

Surface Mount Noise Sources

NC503SM-28

200 kHz to 2 GHz



Specifications

RF Frequency	200 kHz to 2 GHz
Noise Output	31 dB Min ENR
Noise Spectral Density (N_o)	-143 dBm/Hz Min
Flatness	2 dB P-P Max
Peak Factor	5:1
Bias Voltage	28 V
Supply Current	10 mA Max
Impedance	50 ohms

Package and Connectivity

Construction	Axial Lead
--------------	------------

Environmental

Operating Temperature	0 to 70 °C
Storage Temperature	-65 to 125 °C

Notes

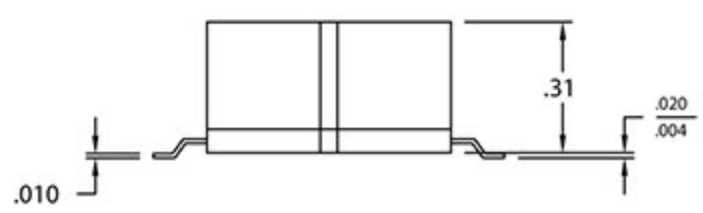
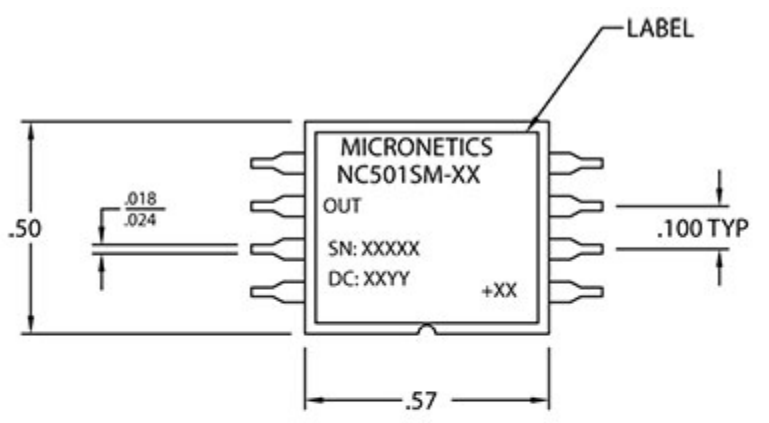

Specifications subject to change without notice



